

**THANK YOU FOR BUYING A INDESIT PRODUCT**

In order to receive a more complete assistance, please register your product on [www.indesit.com/register](http://www.indesit.com/register)



**Prior to using the appliance, carefully read the Safety and installation instructions.**



Prior to using the appliance, the bolts used for transport must be removed. For detailed instructions on the removal procedure, consult the safety and installation instructions.

**CONTROL PANEL**

1. ON/OFF button
2. START/PAUSE button and indicator light
3. TEMPERATURE button
4. DISPLAY
5. OPTIONS button
6. DRYING ONLY button
7. DRYING button
8. DELAYED START button
9. SPIN button
10. WASH CYCLE SELECTOR KNOB
11. PUSH & GO button

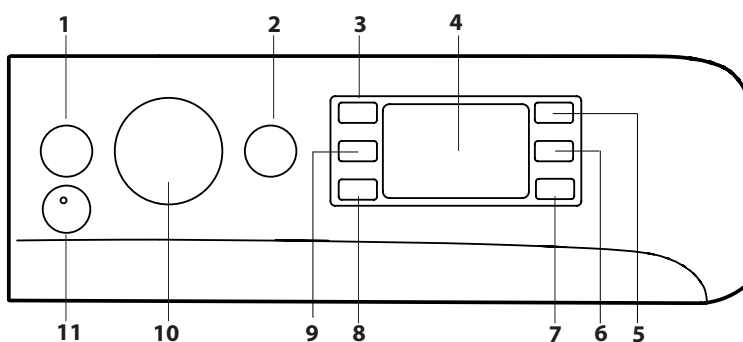

**WASH CYCLE TABLE**

Maximum load 9 kg  
Power input in off mode 0.5 W / in left-on mode 8 W

Wash cycle	Temperature		Max. spin speed (rpm)	Max. load for washing (kg)	Duration (h : m)	Drying	Max. load for drying (kg)	Detergents and Additives		Recommended detergent			Residual dampness % (***)	Energy consumption kWh	Total water lt	Laundry temperature °C
	Setting	Range						Wash	Fabric softener	Powder	Liquid	Capsule (4)				
1 <b>Mixed</b> (👕)	30 °C	30 °C	1200	3.5	**	-	-	●	○	-	✓	-	-	-	-	
2 <b>Shirt</b> (👔)	40 °C	☀️ - 40 °C	600	2	**	-	-	●	○	-	✓	✓	-	-	-	
3 <b>ARIEL PODS</b>	30 °C	30 °C	1000	4.5	**	-	-	-	○	-	-	✓	-	-	-	
4 <b>Wool</b>	40 °C	☀️ - 40 °C	800	2	**	●	2	●	○	-	✓	-	-	-	-	
5 <b>20°C</b>	20 °C	☀️ - 20 °C	1400	9	1:50	●	6	●	○	-	✓	-	49	0.160	90	22
6 <b>Cotton (2)</b>	40 °C	☀️ - 60 °C	1400	9	3:55	●	6	●	○	✓	✓	✓	49	1.400	105	45
7 <b>Synthetics (3)</b>	40 °C	☀️ - 60 °C	1200	4	2:55	●	4	●	○	✓	✓	✓	35	0.800	55	43
8 <b>Mixed</b>	40 °C	☀️ - 40 °C	1000	9	**	●	6	●	○	-	✓	✓	-	-	-	-
9 <b>Eco 40-60 (1) (Wash)</b>	40 °C	40 °C	1351	9	3:48	●	-	●	○	✓	✓	✓	53	0.730	59	35
			1351	4.5	2:54	●	6	●	○	✓	✓	✓	53	0.515	57	32
			1351	2.5	2:15	●	-	●	○	✓	✓	✓	53	0.280	38	23
10 <b>White</b>	60 °C	☀️ - 90 °C	1400	9	2:45	●	6	●	○	✓	✓	✓	49	0.900	90	55
11 <b>Rapid 15min</b>	20 °C	☀️ - 20 °C	1200 (****)	1.5	**	-	-	●	○	-	✓	-	-	-	-	-
12 <b>Rapid 45min Full Load</b>	40 °C	☀️ - 40 °C	1200	9	**	-	-	●	○	-	✓	-	-	-	-	-
13 <b>Wash &amp; Dry 45min</b>	30 °C	30 °C	1400	1	**	●	1	●	○	-	✓	-	-	-	-	-
14 <b>Delicates 30°C</b>	30 °C	☀️ - 30 °C	600 (****)	1	**	●	1	●	○	-	✓	-	-	-	-	-
🌀 <b>Rinse + Spin</b>	-	-	1400	9	**	●	6	-	○	-	-	-	-	-	-	-
🌀 <b>Spin + Drain *</b>	-	-	1400	9	**	●	6	-	-	-	-	-	-	-	-	-

● Required dosage ○ Optional dosage - 4) Minimum 30°C recommended for usage of Capsule detergent.

9 <b>Eco 40-60 (5) (Wash&amp;Drying)</b>	40 °C	40 °C	1351	6	9:20	●	6	●	○	✓	✓	-	0	3.800	75	33
			1351	3	5:10	●	3	●	○	✓	✓	-	0	1.980	47	32

The cycle duration indicated on the display or instruction manual is an estimate based on standard conditions. The actual duration may vary in relation to several factors, such as the temperature and pressure of the incoming water, ambient temperature, amount of detergent, load quantity and type, load balancing and any additional options selected. The values given for programmes other than the Eco 40-60 programme are indicative only.

**1) Eco 40-60 (Wash) - Test wash cycle in compliance with EU Ecodesign regulation 2019/2014.** The most efficient programme in terms of energy and water consumption for washing normally soiled cotton laundry.  
**Note:** spin speed values shown on the display can slightly differs from the values stated in the table.

**5) Eco 40-60 (Wash & Drying)- Test wash and drying cycle in compliance with EU Ecodesign regulation 2019/2014.** To access "wash and dry" cycle select "Eco 40-60" wash programme and set option level to "🌀". The most efficient programme in terms of energy and water consumption for washing and drying normally soiled cotton laundry. At the end of cycle the garments can be immediately stored to the cupboard.

**For all testing institutes:**

- 2) Long cotton cycle: set programme 6 at temperature 40°C.
- 3) Long synthetics cycle: set cycle 7 at a temperature of 40°C.

\* By selecting the 🌀 cycle and excluding the spin cycle, the washer-dryer will drain only.

\*\* The duration of the wash cycles can be checked on the display.

\*\*\* After programme end and spinning with maximum selectable spin speed, in default programme setting.

\*\*\*\* The display will show the suggested spin speed as default value.

**PRODUCT DESCRIPTION**

1. Top
2. Detergent dispenser drawer
3. Control panel
4. Handle
5. Porthole door
6. Drain pump (behind the plinth)
7. Plinth (removable)
8. Adjustable feet (2)

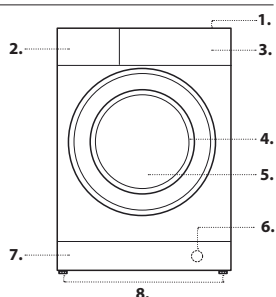

**DETERGENT DISPENSER DRAWER**

**Compartment 1:** Do not insert detergent in this compartment.  
**Compartment 2: Washing detergent (powder or liquid)**

If liquid detergent is used, the removable plastic partition A (supplied) should be used for proper dosage.

If powder detergent is used, insert the partition into slot B.

**Compartment 3: Additives (fabric softener, etc.)** The fabric softener must never exceed the "max" level indicated on the central pin.

! The detergent drawer is suitable only for Liquid and Powder detergent. No Capsule detergent allowed.

The Capsule detergent have to be placed into the drum before the load.  
*Make sure to use the correct Capsule detergent dosage amount recommended by Manufacturer.*

! Use powder detergent for white cotton garments, for pre-washing, and for washing at temperatures over 60°C.

! Follow the instructions given on the detergent packaging.

! To remove the drawer, press lever C and pull the drawer outwards.

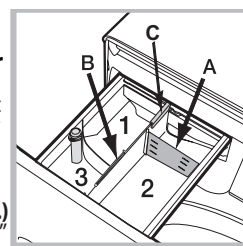

## WASH CYCLES

Follow the instructions on the symbols of the garment's wash care label. The value indicated in the symbol is the maximum recommended temperature for washing the garment.

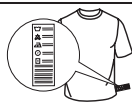

**Mixed** : Mixed + Steam cycle is ideal for cotton or synthetic fabrics, as it washes at a temperature of 30°C and a maximum spin speed of 1200 rpm. Max load 3,5 kg (cycle duration 59'). During the last phase of the cycle garments will be treated with steam, that will relax the fibres making ironing easier and quicker.

**Shirt** : Use the special wash cycle to wash shirts in different fabrics and colours to guarantee they receive the best possible care. During the last phase of the cycle garments will be treated with steam, that will relax the fibres.

**ARIEL PODS**: A 30°C short cycle designed to wash a mixed load of cotton and synthetics fabrics, recommended for the use of PODS detergent.

### Wool - Wool Care

The wool wash cycle of this machine has been approved by The Woolmark Company for the washing of machine washable wool products provided that the products are washed according to the instructions on the garment label and those issued by the manufacturer of this washing machine. The Woolmark symbol is a Certification mark in many countries. (M2227)



**20°C**: for washing lightly soiled cotton garments, at a temperature of 20 °C.

**Cotton**: suitable for washing towels, underwear, table cloths, etc. made of resistant linen and cotton that are moderately to heavily soiled.

**Synthetics**: specific for synthetic items. If the dirt is difficult to remove, the temperature can be increased up to 60° and powder detergent can be used too.

**Mixed**: for washing lightly to normally soiled resilient garments in cotton, linen, synthetic fibres and mixed fibres.

**Eco 40-60**: for washing normally soiled cotton garments declared to be washable at 40 °C or 60 °C, together in the same cycle. This is the standard cotton programme and the most efficient in terms of water and energy consumption.

! As specified, this wash cycle only runs at 40 °C.

**White**: suitable for resistant linen and cotton that are heavily soiled.

**Rapid 15min**: this programme is designed to wash lightly soiled garments at 20° (excluding wool and silk) with 1.5 kg maximum load in a short time: it only lasts 15 minutes and allows for saving time and energy.

**Rapid 45min Full Load**: Suitable for washing a full load of cotton clothes moderately soiled in 45 minutes.

**Wash&Dry 45min**: select programme 13 for washing and drying lightly soiled garments (Cotton and Synthetic) in a short time. This cycle may be used to wash and dry a laundry load of up to 1 kg in just 45 minutes. To achieve optimum results, use liquid detergent and pre-treat cuffs, collars and stains.

**Delicates 30°C**: use programme 14 to wash very delicate garments. It is advisable to turn the garments inside out before washing them. For best results, use liquid detergent on delicate garments.

When selecting an exclusively time-based drying function, a drying cycle is performed at the end of the wash cycle that is particularly delicate, thanks to light handling and appropriate temperature control of the water jet.

The recommended durations are:

1 kg of synthetic garments --> 150 min

1 kg of synthetic and cotton garments --> 180 min

1 kg of cotton garments --> 180 min

The degree of dryness depends on the load and fabric composition.

**Rinse + Spin**: designed for rinsing and spinning.

**Spin + Drain**: designed to spin and drain the water.

## DISPLAY

The display is useful when programming the machine and provides a lot of information.

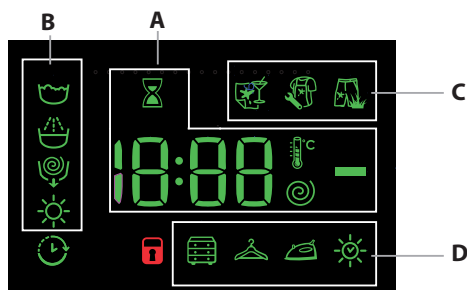

The duration of the available wash cycles and the remaining time of a running cycle appear in section **A**; if the Delayed Start option has been set, the countdown to the start of the selected cycle will appear. Pressing the corresponding button allows you to view either the maximum spin speed, temperature and drying time values attained by the machine during the set wash cycle, or the values selected most recently (if compatible with the set wash cycle).

The hourglass flashes while the machine processes the data on the basis of the selected cycle. After a maximum of 10 minutes, the hourglass icon remains steady lit and the final time remaining is displayed. The "hourglass" icon will then switch off approximately 1 minute after the final time remaining has been displayed.

The "washing phases" relative to the selected cycle and the "washing phase" of the running cycle appear in section **B**:

- Wash
- Rinse
- Spin/ Drain
- Drying

When lit, the symbol indicates that the set "Delayed Start" value has appeared on the display.

There are three levels in section **C** relative to the washing options. Section **D** includes the icons related to the three different drying levels as well as the icon , which lights up when a timed drying option is set.

## DOOR LOCKED INDICATOR

When lit, the symbol indicates that the door is locked. To prevent any damage, wait until the symbol turns off before opening the door. To open the door while a cycle is in progress, press the START/PAUSE button ; if the is off, the door can be opened.

## FIRST-TIME USE

Once the appliance has been installed, and before it is used for the first time, run a wash cycle with detergent and no laundry, by setting the "Auto-Clean" cycle.

## DAILY USE

Prepare the laundry by following the suggestions appearing under the "TIPS AND SUGGESTIONS" section.

### Rapid programming

- Press the ON/OFF button ; the START/PAUSE indicator light will flash slowly green.
- Open the door. Load the laundry while making sure not to exceed the maximum load quantity indicated in the cycle table.
- Pull out the detergent dispenser drawer and pour the detergent into the relevant compartments as described in "DETERGENT DISPENSER DRAWER" section.
- Close the door.

### STARTING CYCLE

Press the PUSH & GO button.

The machine will lock the door ( symbol on) and the drum will start to rotate; the door will be unlocked ( symbol OFF) and then locked again ( symbol on) as preparation phase of each washing cycle. The "Clicking" noise is part of the door locking mechanism. Water will enter the drum and start the washing phase once the door is locked.

### Traditional programming

- Press the ON/OFF button ; the START/PAUSE indicator light will flash slowly green.
- Open the door. Load the laundry while making sure not to exceed the maximum load quantity indicated in the Wash Cycle Table.
- Pull out the detergent dispenser drawer and pour the detergent into the relevant compartments as described in "DETERGENT DISPENSER DRAWER" section.
- Close the door.

- Use the WASH CYCLE selector knob to select the desired wash cycle: it will be associated with a specific temperature and spin speed that can be modified. The duration of the cycle will appear on the display.

- Modify the temperature and/or spin speed: the machine automatically displays the maximum temperature and spin speed values set for the selected cycle, or the most recently-used settings if they are compatible with the selected cycle. Pressing the button gradually reduces the temperature down to the cold wash "OFF" setting. Pressing the button gradually reduces the spin speed until it is completely excluded ("OFF" setting). Pressing these buttons again restores the maximum values.

- Select the desired options.

### STARTING CYCLE

Press the START/PAUSE button.

The machine will lock the door ( symbol on) and the drum will start to rotate; the door will be unlocked ( symbol OFF) and then locked again ( symbol on) as preparation phase of each washing cycle. The "Clicking" noise is part of the door locking mechanism. Water will enter the drum and start the washing phase once the door is locked.

## PAUSING A CYCLE

To pause the wash cycle, press the START/PAUSE button again; the indicator light will flash amber. If the symbol is not lit, the door may be opened. To start the wash cycle from the point at which it was interrupted, press the START/PAUSE button again.

## OPENING THE DOOR, IF NECESSARY

Once a cycle starts, the symbol turns on to signal that the door cannot be opened. While a wash cycle is running, the door remains locked. To open the door while a cycle is under way, for example, to add or remove garments, press the START/PAUSE button to pause the cycle; the indicator light will flash amber. If the symbol is not lit, the door may be opened. Press the START/PAUSE button again to continue the cycle.

## CHANGING A RUNNING WASH CYCLE

To change a wash cycle while it is in progress, pause the washer-dryer using the START/PAUSE button (the relative indicator light will flash amber), then select the desired cycle and press the START/PAUSE button again. ! To cancel a cycle that has already begun, press and hold the ON/OFF button. The cycle will be stopped and the machine will switch off.

## END OF THE CYCLE

This will be indicated by the word "END" on the display; when the symbol switches off, the door may be opened. Open the door, unload the laundry and switch off the machine. If you do not press ON/OFF button, the washing machine will switch off automatically after about a 10 minutes.

## OPTIONS

- If the selected option is not compatible with the set wash cycle, the indicator light will flash and the option will not be activated.



### Stain removal

This option allows for selecting the type of dirt so as to optimally adjust the cycle for removing the stains. The following types of dirt can be selected:

- **Food**, for stains caused by foodstuffs and beverages, for example.
- **Work**, for grease and ink stains, for example.
- **Outdoor**, for mud and grass stains, for example

! The wash cycle duration varies according to the type of selected dirt.

### Delayed Start

To set a delayed start for the selected cycle, press the corresponding button repeatedly until the desired delay period has been reached. When this option has been activated, the symbol lights up on the display. To remove the delayed start setting, press the button until the word "OFF" appears on the display.

### Temperature

Each wash cycle has a pre-defined temperature. To modify the temperature, press the button. The value will appear on the display.

### Spin

Each wash cycle has a pre-defined spin speed. To modify the spin speed, press the button. The value will appear on the display.

### Setting the drying cycle

The first time the button is pressed, the machine will automatically select the maximum drying cycle which is compatible with the selected wash cycle. Subsequent presses will decrease the drying level and then the drying time, until the cycle is excluded completely ("OFF").

Drying may be set as follows:

**A** - Based on the desired laundry dryness level:

**Cupboard** : suitable for laundry which can be put back in a cupboard without being ironed.

**Hanger** : ideal for clothes which do not need to be dried fully.

**Iron** : suitable for clothes which will need ironing afterwards. The remaining dampness softens creases, making them easier to remove.

**B** - Based on a set time period: between **210** and **30** minutes.

If your laundry load to be washed and dried is much greater than the maximum stated load (see adjacent table of wash cycles), perform the wash cycle, and when the cycle is complete, divide the garments into groups and put some of them back in the drum. At this point, follow the instructions provided for a "Drying only" cycle. Repeat this procedure for the remainder of the load. Note: a cooling-down period is always added to the end of each drying cycle.

### Drying only

Press button to perform the drying-only cycle. After selecting the desired cycle (compatible with the type of garments), press button to exclude the washing phase and start the drying phase at the maximum level for the selected cycle. The drying level or time may be set and changed by pressing the drying button . (Not compatible with cycle 13).

### PUSH & GO

To start the Push&Go cycle press and hold the button for 2 seconds.

The indicator lights up to show that the cycle has started. The wash and drying cycle is ideal for cotton or synthetic fabrics, as it washes them at a temperature of 30° and a maximum spin speed of 1000 rpm.

During the drying cycle the maximum temperature is 60°C. At the end of the cycle the residual humidity will be the same as for the "👕" level. Max recommended load 3 kg.

The time displayed is the maximum time allowed by the Push&Go cycle.

If the load is lower than the maximum load or most garment are made of synthetic materials, the actual time of the cycle will be shorter.

*How does it work?*

1. Load the laundry (cotton and/or synthetic garments) and close the door.

2. Pour the detergent and/or additives.

3. Start the cycle by pressing and holding the Push&Go button for 2 seconds. The relevant indicator light will turn green and the door will lock (the DOOR LOCKED symbol is lit).

NB: starting the cycle through the Push&Go button activates an automatic non-customisable wash and drying cycle recommended for cotton and synthetic fabrics.

4. The automatic cycle can be used only for washing, excluding the drying phase. Press the Push&Go button and then the drying button : the drying icon of the "👕" level will switch off. Maximum load for washing-only is 3 kg. The cycle cannot be customised further.

To open the door while an automatic cycle is under way, press the START/PAUSE button. If the DOOR LOCKED symbol is off, the door may be opened only during the washing phase. Press the START/PAUSE button again to restart the wash cycle from the point at which it was interrupted.

5. At the end of the wash cycle the word END will light up.

## TIPS AND SUGGESTIONS

### Divide the laundry according to:

Type of fabric (cotton, mixed fibres, synthetics, wool, garments to be hand-washed). Colour (separate coloured garments from whites, wash new coloured garments separately). Delicates (small garments – such as nylon stockings – and items with hooks – such as bras: insert them in a fabric bag).

### Empty the pockets:

Objects such as coins or lighters can damage the washer-dryer and the drum. Check all buttons.

### Follow the dosage recommendation / additives

It optimizes the cleaning result, it avoids irritating residues of surplus detergent in your laundry and it saves money by avoiding waste of surplus detergent.

## Use low temperature and longer duration

The most efficient programmes in terms of energy consumption are generally those that perform at lower temperatures and longer duration.

### Observe the load sizes

Load your washing machine up to the capacity indicated in the "Wash Cycle Table" table to save water and energy.

### Noise and remaining moisture content

They are influenced by the spinning speed: the higher the spinning speed in the spinning phase, the higher the noise and the lower the remaining moisture content.

## CARE AND MAINTENANCE

*Before performing cleaning and maintenance, switch the washer-dryer off and disconnect it from the mains power. Do not use flammable liquids to clean the washer-dryer. Clean and maintain your washer-dryer periodically (at least 4 times per year).*

### Disconnect the water and power supplies

Close the water tap after every wash. This will limit wear on the hydraulic system inside the washer-dryer and help to prevent leaks. Unplug the washer-dryer when cleaning it and during all maintenance work.

### Clean the washer-dryer

The outer parts and rubber components of the appliance can be cleaned using a soft cloth soaked in lukewarm soapy water. Do not use solvents or abrasives. The washer-dryer has a "Auto-clean" cycle for its internal parts; it must be run without any load in the drum.

To optimise this cycle, it is possible to use either detergent (10% of the quantity specified for lightly soiled garments) or special additives to clean the washer-dryer. We recommend running a cleaning cycle every 40 wash cycles. To start the cycle press buttons and simultaneously for 5 seconds. The cycle will start automatically and will run for about 70 minutes. To stop the cycle, press the START/PAUSE button.

### Clean the detergent dispenser drawer

Wash it under running water; this operation should be repeated frequently.

### Care for the door and drum

Always leave the porthole door ajar in order to prevent unpleasant odours from forming.

### Clean the pump

The washer-dryer is fitted with a auto-cleaning pump that does not require any maintenance. Small items (such as coins or buttons) may sometimes fall into the protective pre-chamber situated at the base of the pump.

! Make sure the wash cycle has ended and unplug the appliance.

To access the pre-chamber:

1. remove the cover panel on the front of the machine by first pressing it in the centre then pushing downwards on both sides to extract it;
2. loosen the drainage pump cover by turning it anti-clockwise: it is normal for some water to leak out;
3. clean the inside thoroughly;
4. screw the cover back on;
5. put the panel back in place, making sure the hooks slot in place before pushing the panel onto the appliance.

### Check the water inlet hose

Check the water inlet hose at least once a year. If it is cracked or broken, it must be replaced: during wash cycles, the high pressure of the water could suddenly split the hose open.

! Never use hoses that have already been used.

## LOAD BALANCING SYSTEM

Before every spin cycle, to avoid excessive vibrations before every spin and to distribute the load in a uniform manner, the drum rotates continuously at a speed which is slightly greater than the washing rotation speed. If, after several attempts, the load is not balanced correctly, the machine spins at a reduced spin speed. If the load is excessively unbalanced, the washer-dryer performs the distribution process instead of spinning. To encourage improved load distribution and balance, we recommend small and large garments are mixed in the load.

## ACCESSORIES

Contact our Technical Assistance Service to check whether the following accessories are available for this washer-dryer model.

### Stacking kit

With this accessory you can secure the tumble dryer to the upper part of your washer-dryer to save space and facilitate loading and unloading of the tumble dryer.

## TRANSPORT AND HANDLING

*Do not lift the washer-dryer by gripping it from the upper section.*

Unplug the appliance and close the water tap. Check that the door and detergent dispenser drawer are tightly closed. Detach the filling hose from the water tap then detach the drain hose. Empty all the water remaining in the hoses and secure the latter so that they do not get damaged during transport. Apply the transport bolts back on. Repeat, in reverse order, the transport bolt removal procedure described in the "Health & Safety and Installation Guides".

**DEMO MODE:** to deactivate this function, switch the washing machine OFF. Then press and hold "Start/Pause" button, within 5 seconds press also "ON/OFF" button and hold both buttons for 2 seconds.

## TROUBLESHOOTING

Your machine could occasionally fail to work. Before contacting the Technical Assistance Service, make sure that the problem cannot be easily solved using the following list.

Anomalies	Possible causes / Solution
<b>The washer-dryer does not start.</b>	The appliance is not plugged into the socket, or not sufficiently to make contact.
	There is no power in the house.
<b>The wash cycle does not start.</b>	The washing machine door is not closed properly.
	The ON/OFF button has not been pressed.
	The START/PAUSE button has not been pressed.
	The water tap has not been opened.
	A delay has been set for the start time.
<b>The washer-dryer does not fill with water ("H2O" flashes on the display).</b>	The water inlet hose is not connected to the tap.
	The hose is bent.
	The water tap has not been opened.
	There is no water supply in the house.
	The pressure is too low.
	The START/PAUSE button has not been pressed.
<b>The washer-dryer continuously loads and unloads water.</b>	The drain hose is not fitted between 65 and 100 cm from the floor.
	The free end of the hose is immersed in water.
	The wall drainage system does not have a breather pipe.
	If the problem persists even after these checks, turn off the water tap, switch the appliance off and contact the Technical Assistance Service. If the home is on one of the upper floors of a building, there may be problems relating to back-siphonage, causing the washing machine to fill with water and drain continuously. Special anti-siphon valves are available in shops and help to prevent this inconvenience.
<b>The washer-dryer does not drain or spin.</b>	The cycle does not include drainage: with certain cycles it must be started manually.
	The drain hose is bent.
	The drainage duct is clogged.
<b>The washer-dryer vibrates a lot during the spin cycle.</b>	The drum was not unlocked correctly during installation.
	The washing machine is not level.
	The washing machine is tucked between furniture cabinets and the wall.
<b>The washer-dryer leaks.</b>	The water inlet hose is not screwed on properly.
	The detergent dispenser drawer is obstructed.
	The drain hose is not properly attached.
<b>The "Options" and START/PAUSE indicator lights flash rapidly and the display visualises an error code (e.g.: F-01, F-...).</b>	Switch off the machine and unplug it, wait for approximately 1 minute and then switch it back on again. If the problem persists, contact the Technical Assistance Service.
<b>There is too much foam.</b>	The detergent is not suitable for machine washing (it should be marked with "for washing machine use" or "hand wash and machine wash" or similar).
	Too much detergent was used.
<b>The PUSH &amp; GO function does not activate.</b>	After switching the machine on, another option/program different from PUSH & GO was activated. Switch the machine off and press the PUSH & GO button.
<b>The washer-dryer does not dry.</b>	The appliance is not plugged into the socket, or not enough to make contact.
	There has been a power failure.
	The appliance door is not shut properly.
	A DELAY TIMER has been set.
	DRYING is in the OFF position.

### Policies, standard documentation, ordering of spare parts and additional product information can be found by:

- Using the QR code in your appliance
- Visiting the website <http://docs.indesit.eu> and [parts-selfservice.indesit.com](http://parts-selfservice.indesit.com)
- Alternatively, **contact our After-sales Service** (See phone number in the warranty booklet). When contacting our After-sales Service, please state the codes provided on your product's identification plate.
- For User's Repair & Maintenance Information visit [www.indesit.com](http://www.indesit.com)

The model information can be retrieved using the QR-Code reported in the energy label. The label also includes the model identifier that can be used to consult the portal of the registry at <https://eprel.ec.europa.eu>

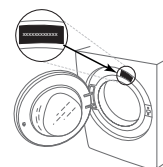

# CLEANING & MAINTENANCE

**For any cleaning and maintenance, switch off and unplug the washing machine.  
Do not use flammable fluids to clean the washing machine.**

## CLEANING THE OUTSIDE OF THE WASHING MACHINE

Use a soft damp cloth to clean the outer parts of the washing machine.

Do not use glass or general purpose cleaners, scouring powder or similar to clean the control panel – these substances might damage the printing.

## CHECKING THE WATER SUPPLY HOSE

Check the inlet hose regularly for brittleness and cracks. If damaged, replace it by a new hose available through our After-Sales Service or your specialist dealer. Depending on the hose type:

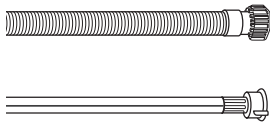

If the inlet hose has a transparent coating, periodically check if the colour intensifies locally. If yes, the hose may have a leak and should be replaced.



For water stop hoses: check the small safety valve inspection window (see arrow). If it is red, the water stop function was triggered, and the hose must be replaced by a new one. For unscrewing this hose, press the release button (if available) while unscrewing the hose.

## CLEANING THE MESH FILTERS IN THE WATER SUPPLY HOSE

1. Close water tap and unscrew the inlet hose.

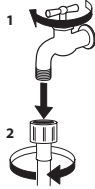

2. Clean the mesh filter at the hose's end carefully with a fine brush.

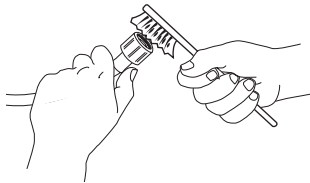

3. Now unscrew the inlet hose on the back of the washing machine by hand. Pull out the mesh filter from the valve on the back of the washing machine with pliers and carefully clean it.

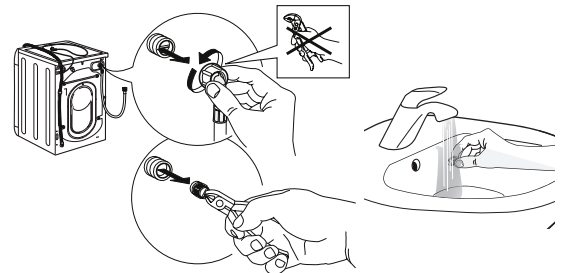

4. Insert the mesh filter again. Connect the inlet hose to water tap and washing machine again. Do not use a tool to connect the inlet hose. Open the water tap and check that all connections are tight.

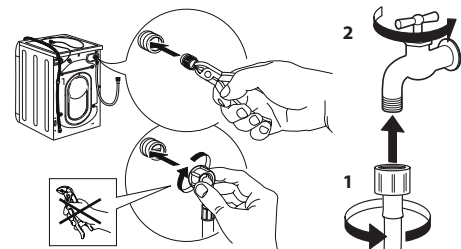

## CLEANING THE DETERGENT DISPENSER

Remove the dispenser by raising it and pulling it out (see figure).

Wash it under running water; this operation should be repeated frequently.

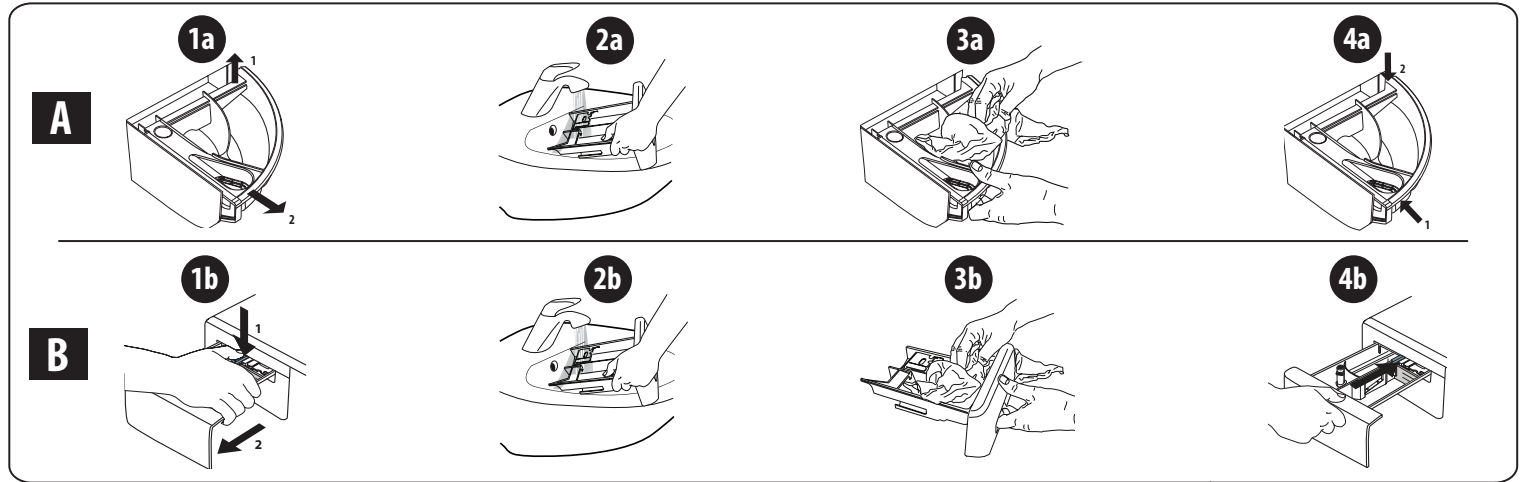

## CLEANING THE WATER FILTER / DRAINING RESIDUAL WATER

**Switch off and unplug the washer- dryer before cleaning the water filter or draining residual water. If you used a hot wash programme, wait until the water has cooled down before draining any water. Clean the water filter regularly every 3 months, to avoid that the water cannot drain after the wash due to obstruction of the filter. If the water cannot drain, the display indicates that the water filter may be clogged.**

1. Remove the kick panel: Using a screwdriver, do that which is shown in the following figure.

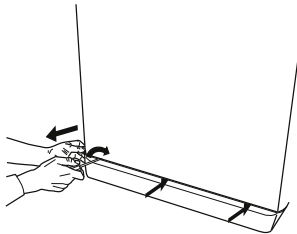

2. Container for the drained water: Place a low and wide container under the water filter in order to collect the residual water.

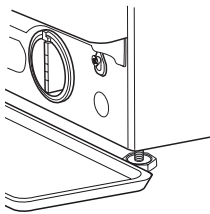

3. Drain the water: Slowly turn the filter counter-clockwise until all the water has come out. Allow the water to flow out without removing the filter. Once the container is full, close the water filter by turning it clockwise. Empty the container. Repeat the procedure until all the water has been drained.

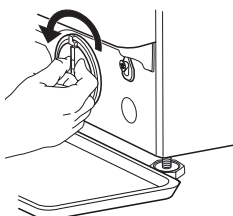

4. Remove filter: Lay a cotton cloth beneath the water filter, which can absorb a small amount of rest water. Then remove the water filter by turning it out anticlockwise.

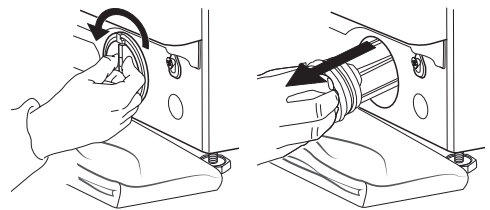

5. Clean the water filter: remove residues in the filter and clean it under running water.

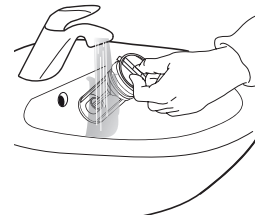

6. Insert the water filter and reinstall the plinth: Reinsert the water filter again by turning it in clockwise direction. Make sure to turn it in as far as it goes; the filter handle must be in vertical position. To test water tightness of the water filter, you can pour about 1 liter of water into the detergent dispenser. Then reinstall the plinth.

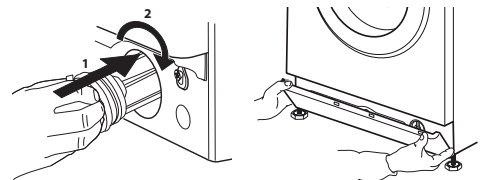

# TRANSPORT AND HANDLING

**Never lift the washing machine by holding it at the worktop.**

1. Pull out the mains plug, and close the water tap.
2. Make sure that door and detergent dispenser are properly closed.
3. Disconnect the inlet hose from the water tap, and remove the drain hose from your draining point. Remove all rest water from the hoses, and fix them so that they cannot get damaged during transport.

4. Refit the transport bolts. Follow the instructions for removing the transport bolts in the "Installation Guide" in reverse order.

**Important:** Do not transport the washing machine without having fixed the transport bolts.

## AFTER-SALES SERVICE

### BEFORE CALLING THE AFTER-SALES SERVICE

1. See if you can solve the problem by yourself with the help of the suggestions given in the **TROUBLESHOOTING**

### IF AFTER THE ABOVE CHECKS THE FAULT STILL OCCURS, GET IN TOUCH WITH THE NEAREST AFTER-SALES SERVICE

To receive assistance, call the number shown on the warranty booklet.

When contacting our Client After sales service, always specify:

- a brief description of the fault;
- the type and exact model of the appliance;

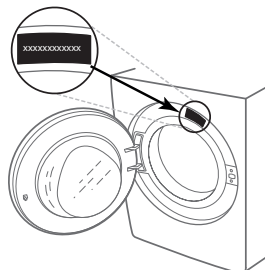

2. Switch the appliance off and back on again to see if the fault persists.

- the service number (number after the word Service on the rating plate).

**SERVICE** 0000 000 00000



- your full address;
- your telephone number.

If any repairs are required, please contact an authorised after-sales service (to guarantee that original spare parts will be used and repairs carried out correctly).